

DNC 系列气缸
DNC Series Cylinder



订购码
Ordering code

DNC	63 × 50	PPV	-	A	-	S2
<p>型号 DNC:基本型 HNC:轴向脚座 FNC:前后法兰 ZNCF:前后轴销 ZNCM:中间轴销 SNCB:单耳座 SNCL:双耳座</p> <p>Mounting DNC:Basic type HNC:Foot mounting FNC:Flange mounting ZNCF:Pin mounting ZNCM: SNCB:Single clevis SNCL:Double clevis</p>	<p>缸径 Bore</p>	<p>行程 stroke</p>	<p>缓冲 空白:无缓冲 PPV:带缓冲</p> <p>Cushioning Blank:Without cushioning PPV:With cushioning</p>	<p>磁石 Magnet Blank:Without magnet A:With magnet</p>		<p>S2:双活塞杆 K2:加长外螺纹 K3:前端内螺纹 K7:外标准螺纹 K8:加长活塞杆</p> <p>S2:Through piston rod K2:Extend male piston rod thread K3:Female piston rod thread K7:Piston rod with external hexagon K8:Extended piston rod</p>

规格
Specifications

缸径 / Bore(mm)	32	40	50	63	80	100
工作介质 Fluid	经过滤的空气 / Filter air					
动作形式 Operation	复动型 / Double actioning					
保证耐压力 Proof pressure	1.5MPa					
最高使用压力 Max. operating pressure	1.0MPa					
最低工作压力 Min. operating pressure	0.1MPa					
缓冲形式 Cushioning	空气缓冲 (标准) / Air cushioning(Standard)					
环境温度 Operating temperature	5~60°C					
使用速度 Operating piston speed	50~500mm/s					
行程误差 Allowable stroke tolerance	0~250 ^{+1.0} ₀ 251~1000 ^{+1.5} ₀ 1001~1500 ^{+2.0} ₀					
使用寿命 Operating life	不少于4000公里 / Not less than 4000Km					
润滑剂 Lubrication	未装备 / Not required					
接管口径 Port size	G1/8"		G1/4"		G3/8"	G1/2"

行程 Stroke

缸径 Bore	标准行程 Standard stroke	PPV缓冲距离 Cushioning length PPV	最大行程范围 Max.stroke range	缸径 Bore	最小行程范围 Min.stroke of proximity sensor	最大行程范围 Type of proximity sensor
32	25 40 50 80 100 125 160	20	10~2000	32	32	KCK2400C
40				40		
50	200 250 320 400 500	22		50	50	
63				63		
80	32	32		80	80	
100				100	100	

结构图 Structural drawing

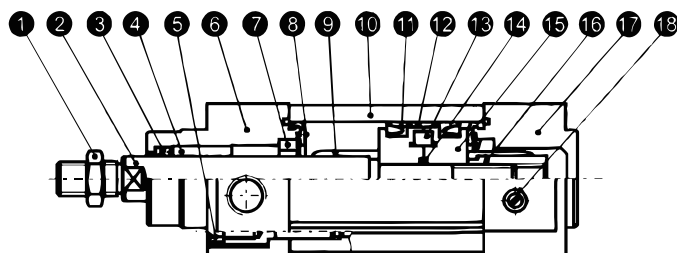

零件部分 Component part

编号 No.	名称 Name	原料 Material	编号 No.	名称 Name	原料 Material
1	螺母 Nut	35	10	缸筒 Cylinder tube	A6063-TS
2	活塞杆 Piston rod	45	11	Y形圈 "Y" Ring	丁腈橡胶 NBR
3	轴封 Axes envelop	PU	12	衬圈 Washer	F4
4	导封 Guilde envelop	含油轴承 Sleeve bearing	13	磁环 Magnetic ring	磁塑 Magnetic plastic
5	连杆螺母 Rod bolt	35	14	O形圈 "O" Ring	丁腈橡胶 NBR
6	前端盖 Front cover	ZZnAl4-1	15	前后活塞 Front and back piastion	LY12
7	缓冲密封圈 Cushioning seal	PU	16	压紧螺母 Compaction nut	LY12
8	缓冲密封圈 Cushioning pad	PU	17	后端盖 Back cover	ZZnAl4-1
9	缓冲活塞 Cushioning piston	POM	18	调节阀针 Adjustable valve pin	HPb59-1



DNC 系列气缸

DNC Series Cylinder

尺寸 Dimensions

基本型
Basic type
DNC...PPV-A

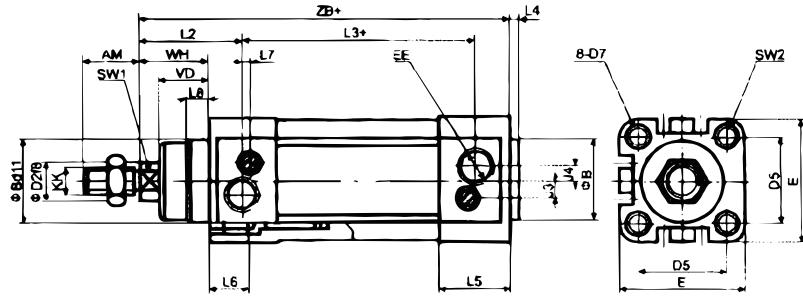

缸径 Bore	AM	B	D2	D5	D7	E	EE (G)	J3	J4	KK	L2	L3	L4	L5	L6	L7	L8	SW1	2VD	VD	WH	ZB
32	22	30	12	32.5	M6	45	1/8	6	5.2	M10X1.25	41.6	62.8	4	25.1	16	3.3	10	10	6	18	26	120
40	24	35	16	38	M6	54	1/4	8	6	M12X1.25	44	77	4	29.6	16	3.6	11.5	13	6	21.5	30	135
50	32	40	20	46.5	M8	64	1/4	10	8.5	M16X1.5	51	78	4	29.6	17	5.1	11.5	17	8	28	37	143
63	32	45	20	56.5	M8	75	3/8	12.4	10	M16X1.5	54	87	4	35.6	17	6.6	15	17	8	28.5	37	158
80	40	45	25	72	M10	93	3/8	12.5	8	M20X1.5	62.4	95.2	4	35.9	17	10.5	15.7	22	10	34.7	46	174
100	40	55	25	89	M10	110	1/2	11.8	10	M20X1.5	69.8	100.4	4	38.8	17	8	19.2	22	10	38.2	51	189

双活塞杆型
Double rod cylinder type
DNC...PPV-A

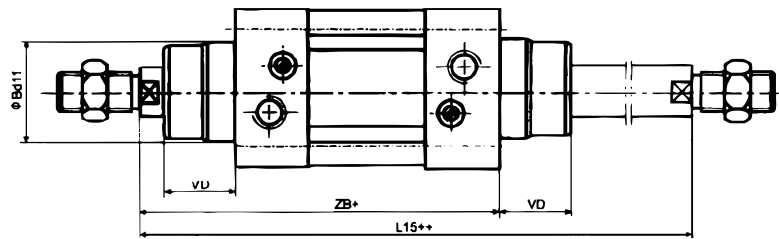

缸径 Bore	B	L15	VD	ZB
32	30	146	18	120
40	35	165	21.5	135
50	40	180	28	143
63	45	195	28.5	158
80	45	220	34.7	174
100	55	240	38.2	189
125	60	291	46	225

DNC 系列气缸

DNC Series Cylinder

尺寸

Dimensions

HNC...PPV-A 轴向脚座
HNC...PPV-A mounting

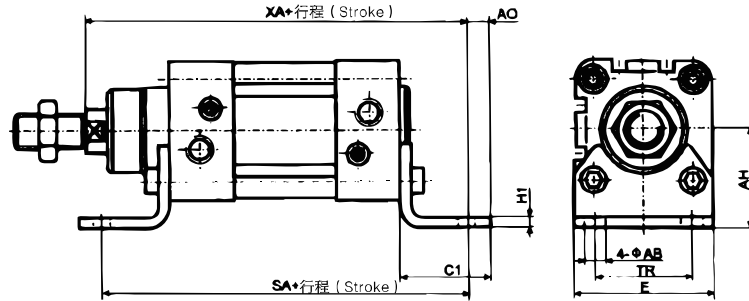

缸径 Bore	AB	AH	AO	C1	E	H1	SA	TR	XA
32	7	32	6.5	30.5	45	5	142	32	144
40	10	36	9	37	54	5	161	36	163
50	10	45	10.5	41.5	64	6	170	45	175
63	10	50	12.5	44.5	75	6	185	50	190
80	12	63	15	56	93	6	210	63	215
100	14.5	71	17.5	58.5	110	6	220	75	230

FNC...PPV-A 前,后法兰
FNC...PPV-A flange mounting

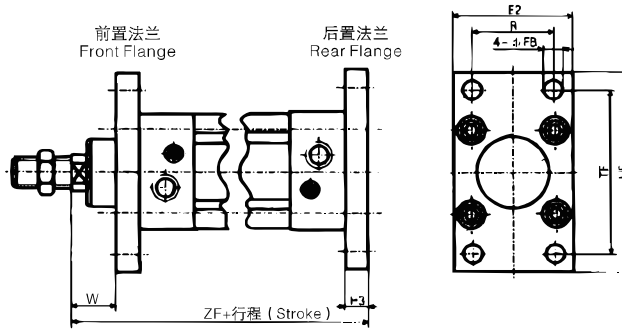

注册：气缸与法兰的连接螺钉采用GB70-85标准件

缸径 Bore	E2	FBH13	H13	R	TF	UF	W	ZF
32	30	7	10	32	64	80	16	130
40	35	9	10	36	72	90	20	145
50	40	9	12	45	90	110	25	155
63	45	9	12	50	100	125	25	170
80	45	12	16	63	126	156	30	190
100	55	14	16	75	150	186	35	205

DNC 系列气缸

DNC Series Cylinder

尺寸 Dimensions

ZNCF...PPV-A
前后轴销
Shaft pin mounting

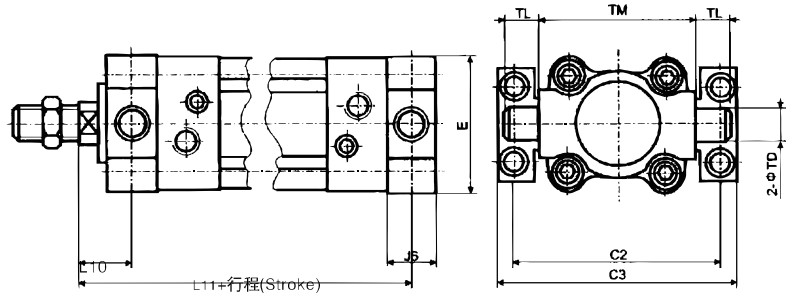

缸径 Bore	C2	C3	E	G4	G5	J6	L10	L11	S7	S8	T4	T5	T6	T7	TDE _{SH7}	TL	TM
32	71	86	45	32	46	16	18	128	6.6	11	15	18	6.8	10.5	12	12	50
40	87	105	54	36	55	20	20	145	9	15	18	21	9	12	16	16	63
50	99	117	64	36	55	25	25	155	9	15	18	21	9	12	16	16	75
68	116	136	75	42	65	25	25	170	11	18	20	23	11	13	20	20	90
80	135	156	93	42	65	32	32	188	11	18	20	33	11	13	20	20	110
100	164	189	110	50	75	32	32	208	14	20	25	28.5	13	16	25	25	132

ZNCM...PPV-A
中间轴销
Shaft pin middle

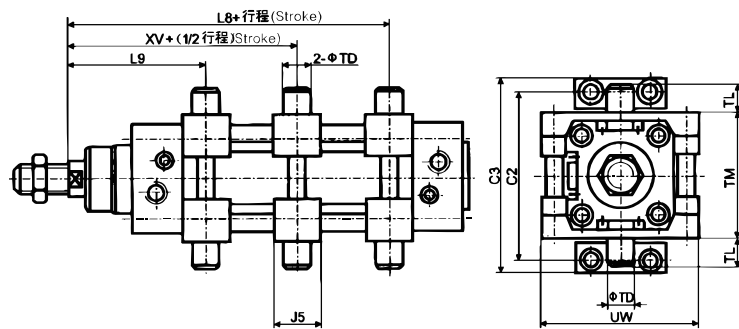

缸径 Bore	C2	C3	J5	L8	L9	TDE _{SH7}	TL	TM	UW	XV
32	71	86	30	80	66	12	12	50	65	73
40	87	105	32	90	76	16	16	63	75	82.5
50	99	117	34	94	84	16	16	75	95	90
63	116	136	41	102	93	20	20	90	105	97.5
80	136	150	44	118	104	20	20	110	130	110
100	164	189	48	126	114	25	25	132	145	120

DNC 系列气缸

DNC Series Cylinder

尺寸

Dimensions

SNCB...PPV-A 单耳座
SNCB...PPV-A single clevis

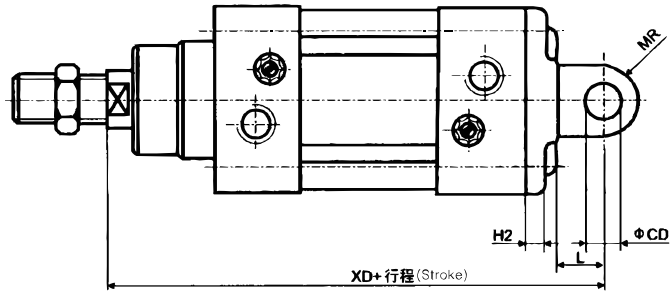
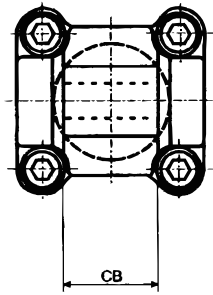

SNCL...PPV-A 双耳座
SNCL...PPV-A double clevis

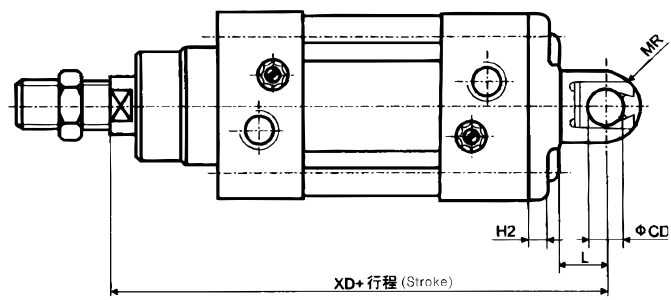
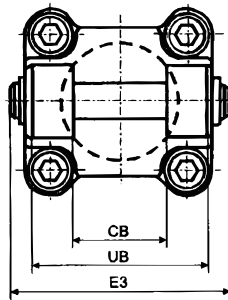

缸径 Bore	CB	BD	E3	H2	L	MR	UB	XD
32	26	10	55	6	13	10	45	142
40	28	12	63	6	16	12	52	160
50	32	12	71	7	16	12	60	170
63	40	16	83	7	21	16	70	190
80	50	16	103	10.5	22	16	90	210
100	60	20	127	10.5	27	20	110	230